



CuS-Rail System kills 99.99% of bacteria, fungus, and viruses.

www.hmrgb.com  
HAEMA INDUSTRIAL



ISO 9001 인증업체



KC mark  
Korea Certification



※ 유니버설디자인 인증획득  
(인증번호: KUD-2022P004)



CuS 황화구리 적용 항균, 항바이러스효과  
30분 이내 바이러스 99.99% 사멸

CuS 범퍼레일/핸드레일 p.2

CuS-Rail System kills 99.99% of bacteria, fungus, and viruses.

병원 · 복지시설 · 요양시설 · 공공시설 · 가정용  
설계 (유니버설디자인, BF인증지원) / 제조 / 시공

2022-09

Impact Protection System

365  
For Your Safety



Impact Protection System

범퍼레일 p.3

NEW 50mm 이격 범퍼핸드레일

Impact Protection System

Handrail & Baluster System



NEW

해마산업

CODEVAL ALUMINIUM



Handrail & Baluster System

핸드레일 & 난간지주 p.10

NEW 클리어뷰 유리난간

Handrail & Baluster System

Deluxe Grab-bar System



Deluxe Grab-bar System

디럭스 안전손잡이 p.15

NEW P형 접이식안전손잡이

Deluxe Grab-bar System

Baby Care System



Baby Care System

영유아 편의용품 p.19

Baby Care System

Curtain Track System

스페인 명품 직수입  
클리어뷰 유리난간 출시!



Curtain Track System

커튼 트랙 p.20

NEW 비말차단 우레탄 커튼

Curtain Track System



Overseas Sales Manager  
Liz Park +82-10-4716-5129

(주)해마산업  
경기도 광주시 곤지암읍 광역로 209 (열미리 437-1)  
전화: 02-471-6500 팩스: 031-798-6888  
이메일: hm@hmrgb.com 홈페이지: http://www.hmrgb.com

HAEMA Industrial Co., Ltd.  
209, Gwangyeo-ro, Gonjam-eup, Gwangju-si, Gyeonggi-do, Korea  
Tel: +82-70-7019-0958 Fax: +82-31-798-6888  
E-mail: hm@hmrgb.com Homepage: http://www.hmrgb.com



Copyright (c) Mar 2022 by HAEMA.  
All rights reserved.



with





올해 창립 32주년을 맞이한 해마산업은 새로운 건축환경의 변화와 요구에 발맞추어 끊임없는 연구개발을 통해 다양한 제품을 선보이며 발전하고 성장해왔습니다.

지금까지의 성과 및 성장에 안주하지 않고 더 큰 도약을 이루기 위해 묵묵히 걸어온 과거와 새로운 미래비전의 가치를 담아 CI를 변경합니다.

새로운 도약의 시기를 맞은 해마산업에 많은 관심과 응원 부탁드립니다.

### 2022년, 해마산업의 새로운 CI를 소개합니다.

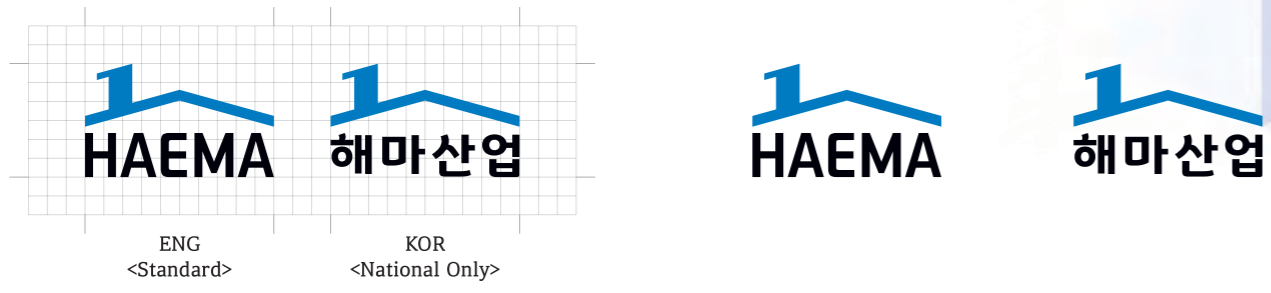

Single color application example



For document top and bottom lettering

PANTONE 2174C  
C 94 M 43 Y 0 K 0  
R 0 G 118 B 206  
HTML 0076CE

PANTONE BLACK 6  
C 100 M 79 Y 44 K 93  
R 16 G 24 B 32  
HTML 101820

PANTONE Cool Gray 8  
C 23 M 16 Y 13 K 46  
R 136 G 139 B 141  
HTML 888B8D

※ CI 사용이 필요한 경우 당사 문의 및 협의바랍니다.

## HOW TO SUPPRESS THE VIRUS WITH HAEMA



**CuS-Rail System kills 99.99% of bacteria, fungus, and viruses.**  
CuS 황화구리 적용 항균, 항바이러스효과  
30분 이내 바이러스 99.99% 사멸

### CuS-Rail System CuS 레일

당사는 반영구적인 내구성을 갖는 물질인 황화구리(CuS) 소재를 독보적인 기술(특허 제10-2167780호)로 균일하게 배합한 원료를 적용하여 세균, 곰팡이 및 바이러스를 **30분 이내 99.99%** 사멸하는 기능성 CuS레일 제품을 생산합니다.

**CuS-Rail System** is produced by applying copper sulfide (CuS), an inorganic antibacterial agent harmless to humans mix compound block and **destroy 99.99%** of bacteria, fungus, and viruses.

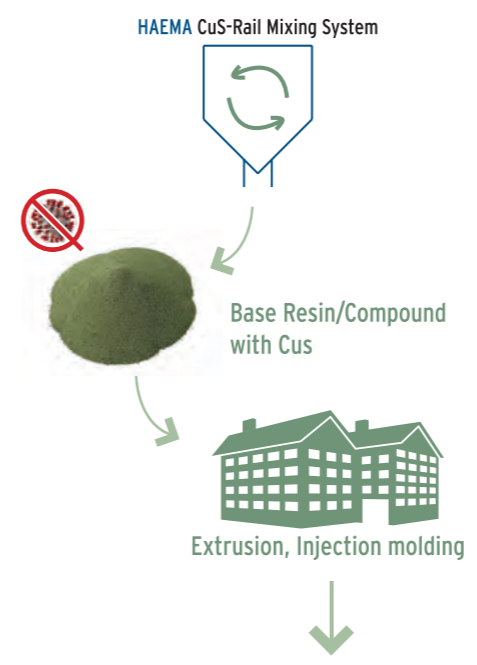

- 항곰팡이 Antifungi**  
ASTM G21, ISO 846법 곰팡이 성장률 0급(완전사멸)  
Mold growth rate 0 grade(complete death) by ASTM G21, ISO 846 method
- 항균 Antibacterial**  
MRSA, E-coli 등의 박테리아를 효과적으로 억제 및 제어  
Effective inhibition and control of bacteria usch as MRSA, E-coli and so on
- 항바이러스 Antiviral**  
코로나, 인플루엔자, 조류독감 등의 바이러스를 빠른 시간 내에 사멸  
Killing viruses such as Corona, Influenza, and Bird flu in a short time



BHRQ-1500 with Anti-Virus



OHRQ-410W

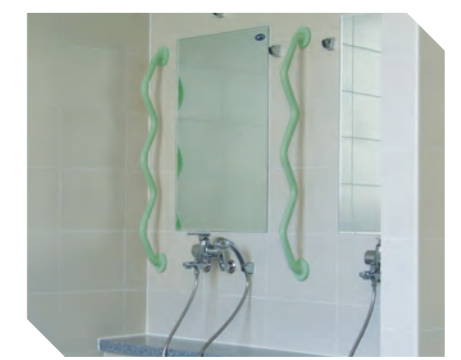

Grab bar with CuS (GBQ)



CuS레일 제품은 원료에 포함된 황화구리의 영향으로 고유의 색상을 형성합니다. 손이 닿는 부분이 연한 녹색이면, 안심하고 사용하세요. Products with **CuS-Rail System** forming own color under the influence of the copper sulfide its contain. If the part you can touch is **light greenish**, use it with confidence.

# Impact Protection System

## BEST EXAMPLE with HAEMA

### ▶ Mediplex Sejong Hospital / 메디플렉스 세종병원



· BHR-160 (#100) with Wood AccentStrip (Oak)



· WGD-130 (#100) for Wall Protect



· CGD-50 (#100) for Corner

### ▶ Korea University Medical Center / 고대안암병원



· BHR-160 (#202) with Accent Strip (#202)



· WGD-130 (#202) for Wall Protect



· CGD-75 (#202) for Corner

### ▶ Yuyu Pharma / 유유제약



· WGD-150 (#412) for Wall Protect



· WGD-200 (#310) for Wall Protect

### ▶ KYUNGHEE MEDICAL CENTER / 경희의료원



· BHR-160 (#501) with Accent Strip (#501)



· DP-200 (#501) for Door Protect

### ▶ GYENGGI CARE CENTER / 경기케어센터



· OHR-410 (#Light Cherry)



· WGD-150 (#431) with Corner Guard

NEW

## Anti Accident Bumper Handrail 안전사고방지 범퍼핸드레일

Available CuS-Rail

### Most Safety Bumper Handrail

- Max. 150mm high handrail with continuous aluminium retainer (6063-T5).
- Embossed Acrylic PVC cover and ABS accessory.
- Color-coordination available include handle part of Endcap.
- Prevents safety accidents with a blockage structure in all directions.
- 50mm distance between handrail and wall.



BHR-1500



BHRQ-1505

\* 핸드레일과 벽사이 간격 : 50mm

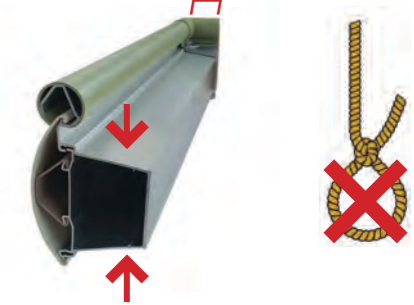

- \* 막힘구조로 끈, 전깃줄 등으로 묶임을 방지합니다.
- \* Prevents tying with strings, power cords, etc.

발명특허 제10-2201414호 안전사고방지 범퍼핸드레일 조립체  
Patent No.10-2201414 Safety accident prevention hand rail assembly



(강북삼성병원)

NEW

## Easy Grip Bumper Handrail 범퍼핸드레일(벽에서 50mm 이격)

Available CuS-Rail

### Conforming to New Standards Bumper Handrail

- Max. 160mm high handrail with continuous aluminium retainer (6063-T5).
- Embossed Acrylic PVC cover and ABS accessory.
- Color-coordination available to match with your existing design scheme.
- 50mm distance between handrail and wall.



BHR-160-50



BHRQ-165-50

### 범퍼핸드레일 타입별 비교

#### Differences according to Bumper Handrail type



BHR-1500



BHR-160 / BHR-140

38mm B/K



BHR-160-50

50mm B/K

**Bumper Handrail**  
범퍼핸드레일

Available CuS-Rail



**Most Popular Bumper Handrail**

- Max. 160mm high handrail with continuous aluminium retainer (6063-T5).
- Embossed Acrylic PVC cover and ABS accessory.
- Color-coordination available to match with your existing design scheme.



**BHR-160**  
**BHRQ-160**



**BHR-165**  
**BHRQ-165** · Accent color on Handgrip (Available wood-pattern)  
· 손스침 별도 색상 적용 (목무늬 가능)



**BHR-169** · Wood-patterned line on Guard part  
· 충격보호부 목무늬 라인 적용

**Simple & Lower Cost Bumper Handrail**

- Max. 140mm high handrail with continuous aluminium retainer (6063-T5).
- Embossed Acrylic PVC cover and ABS accessory.
- Various color selections are available.



**BHR-140**  
**BHRQ-140**



**BHR-145** · Accent colored line on cover  
· 액센트 컬러 라인 적용



**BHR-149** · Wood-patterned line on cover  
· 목무늬 라인 적용



**Wall Bumper Guard**  
월범퍼가드

Available CuS-Rail



**Most Popular Wall Bumper Guard**

- Max. 150mm high Bumper with continuous aluminium retainer (6063-T5).
- Embossed Acrylic PVC cover and ABS End cap. (Selectable NO Embossed)
- Various color selections are available.



**WGD-150**  
**WGDQ-150** · Use as Wall Bumper Guard or Bed Bumper  
· 월범퍼가드 또는 베드범퍼로 사용



**WGD-150N**  
**WGDQ-150N** · No embossed cover & end cap (Smooth)  
· 무엠보 (클리룸, 제약공장 등 특수시설용)



**WGD-159** · Wood-patterned line on cover  
· 목무늬 라인 적용



**WGD-100**  
**WGDQ-100** · Small size wall bumper  
· 소형 월범퍼가드



**Arch Shapes Wall Bumper Guard**

- Superior impact resistance effect of Arch shape bumper.
- Embossed Acrylic PVC cover and ABS accessory.
- Various color selections are available.



**WGD-200**  
**WGDQ-200**



**WGD-130**  
**WGDQ-130** · Use as Wall Bumper Guard or Bed Bumper  
· 월범퍼가드 또는 베드범퍼로 사용

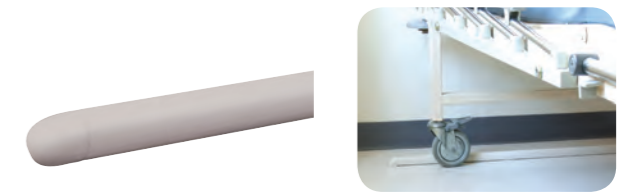

**WGD-30**  
Bed Stopper (W: 30mm)  
· No embossed cover & end cap (Smooth)  
· Use as Wall Bumper Guard or Bed Stopper  
· 무엠보 (벽부 또는 베드스토퍼용)



**Corner Guard & Door Frame Protector**  
코너가드 / 도어프레임가드

**Corner Guard (Surface mount)**

- Aluminium retainer (6063-T5)
- Acrylic PVC cover with ABS End cap



**CGD-50**  
(w : 50 x 50mm)



**CGD-75**  
(w : 75 x 75mm)



**CGD-75-135**  
(w : 75 x 75mm, ∠135)

**Corner Guard (Tape-on)**

- Acrylic PVC



**CG-20**  
(w : 20 x 20mm)



**CG-40**  
(w : 40 x 40mm)

**Door Frame Protector**

- Aluminium retainer (6063-T5)
- Acrylic PVC cover with ABS End cap



**DFP-75**  
(w : 75 x 75mm)



**Wall Panel & Kick Plate**  
월패널 / 킥플레이트

**Wall Panel / Design Panel**

- W2400 x H1200mm (max.)
- Embossed Acrylic PVC
- Standard or custom color available
- Cutting into various shapes available

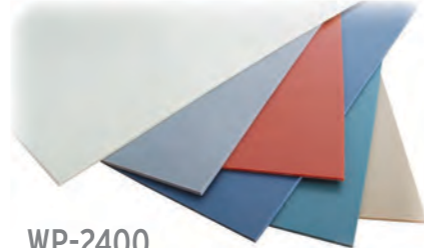

**WP-2400**  
(W:1200mm x L:2400mm x T:1.0mm)



**Design Panel**

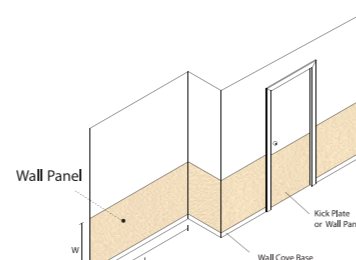

**DP-200**  
(W: 200mm x L: 2400mm x T: 1.0mm)



**DP-150**  
(W: 150mm x L: 2400mm x T: 1.0mm)



**Wall Cove Base**  
경질/연질 걸레받이

**uPVC / Soft Vinyl Wall Cove base**

- 3 Combination extruding method
- No deformation by Moisture and Flame retarding material
- Easy finish by one material

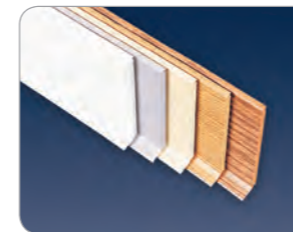

**경질걸레받이**  
uPVC Wall Cove

- 100mm X 5.0t, 2.5m/ea (Standard)
- 75mm X 3.0t
- 75mm X 1.2t
- 60mm X 5.0t

- Light Brown
- Light Gray
- Dark Night

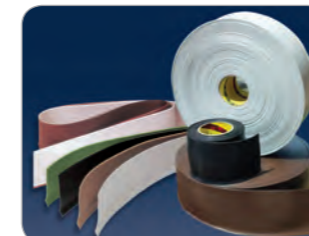

**연질걸레받이**  
Soft Vinyl Wall Cove

- 125mm X 1.6t
- 100mm X 1.6t, 50m/roll (Standard)
- 100mm X 2.5t
- 100mm X 3.5t
- 75mm X 1.8t
- 65mm X 1.6t

- Gray
- Brown
- Black

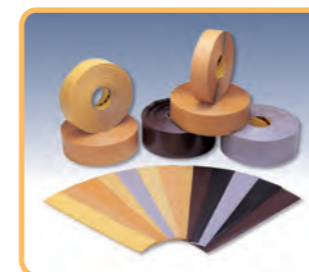

**해마 NoBon**  
NoBon Adhesive Tape Wall Cove

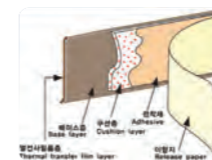

- 100mm x 25m/roll (6ea/box)
- 75mm x 25m/roll (8ea/box)
- 75mm x 25m/roll Wood Patterned



**Heavy Duty Protector**  
헤비듀티범퍼

**Heavy Duty Wall Guard**

- W200mm x D30mm
- Soft synthetic resin
- Standard or custom available (Only dark colors)



**HDWG-200**

**Heavy Duty Corner Guard**

- W90 x 90mm
- D5-10mm Soft synthetic resin
- Standard or custom available (Only dark colors)



**HDCG-100**

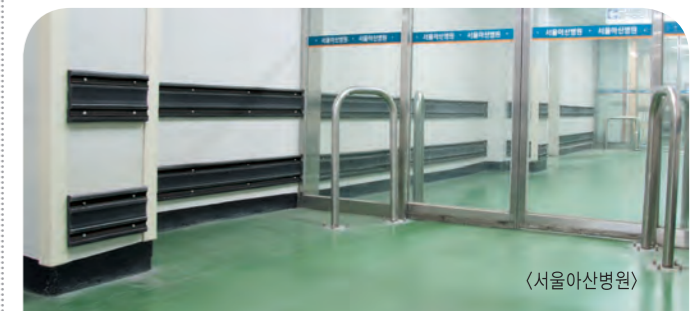

Impact Protection System

Impact Protection System

>> The color of the real product may be differently seen depending on the type of light, an intensity of illumination.  
(실제품의 색상은 조명의 종류, 조도 등에 따라서 다르게 보일 수 있습니다.)

STANDARD COLOR for CuS-Rail



Wood pattern

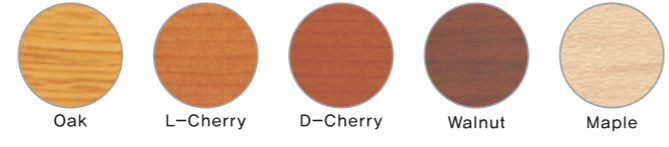

STANDARD COLORS (Custom colors are available.)



Round-grip Handrail  
원형핸드레일

Available CuS-Rail

Round-grip handrail for Wall mounting



Accessories

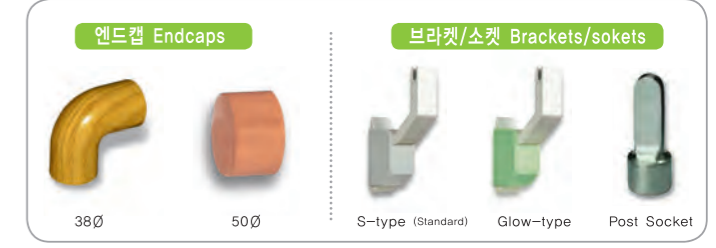

원형핸드레일용 축광브라켓



Round-grip handrail for Baluster



Standard Color pattern for Round-grip Handrail

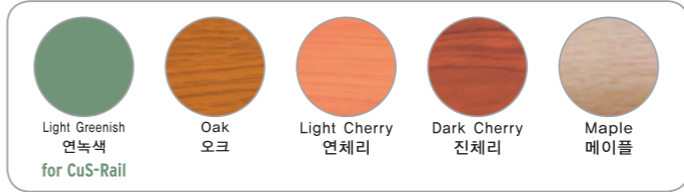

MATERIAL TEST DATA SHEET

>> Specifications may vary by product and may change without prior notice for product improvement.  
(제품은 제품사양에 따라 달라질 수 있으며, 제품 개선을 위해 예고없이 변경될 수 있습니다.)

	TEST CONDUCTED	TEST RESULT	TEST METHOD	
COVER	Material	ACRYLIC PVC (Hard)		
	Thickness	P ≥ 1.0 / 1.5 / 2.0 mm	Minimum thickness varies by products	
	Tensile Strength	above 44 MPa (450 kgf/cm <sup>2</sup> )	KS M 3006:2003, C.R.E	
	Impact	No crack	Load : 1kg steel ball, Drop height : 2m	
	Antimicrobial activity	Value of antimicrobial activity above 2.0 log (ATCC6538P) above 2.0 log (ATCC8739)	FILM-CONTACT Method (JIS Z 2801-2006)	
	Flammability	Char area: within 40cm <sup>2</sup> Char length: within 20cm	MECKEL BURNER	
		V-0	UL 94 2013	
	Fungi	0-rate (PERFECT)	ASTM G 21-96 (2002)	
Heavy metal's Content [mg/kg]	Lead(Pb)	Cadmium(Cd)	Mercury(Hg)	KS M 0032 : 2009 Detection Limit = 1 mg/kg (Just, Detection Limit of Pb is 5 mg/kg.)
	Not Detected	Not Detected	Not Detected	
	Phthalates Content [%]	DEHP	DBP	
Not Detected	Not Detected	Not Detected		
RETAINER	Material	Aluminum 6063-T5		
	Thickness	P ≥ 1.0 / 1.2 / 1.5 / 1.7 / 2.0 mm	Minimum thickness varies by products	
	Tensile Strength	above 150N/mm <sup>2</sup>	KS D 6759 : 2017	
	Yield Strength	above 110N/mm <sup>2</sup>	KS D 6759 : 2017	



**STS pipe infill type Baluster**  
간살형 난간지주 (기본간살/세로간살)



**Quick & Simple installation baluster**

- 900/1200/1500mm high Baluster. (Standard size)
- Applied with 12.7mm infilled Stainless Steel pipes.
- Available with various top handrail such as Stainless pipe, Wood handrail and PVC handrail(OHR).
- Custom colors are available. (PS type)

**난간지주 주문시 추가옵션 선택사항 (주문제작)**

- 하부베이스 맞춤제작으로 난간높이 조절 및 측면설치
- 측면주문제작으로 간살간격 및 유리연결부 위치 조절
- 해안가, 공단지역 등 부식취약지역 설치 시 클리어 코팅
- 현장에 맞춘 별색 분체도장으로 측면색상 변경
- 난간 강도를 높이는 보강지주 추가



PS-L Type  
평철 + 분체도장 측면

SU-L Type  
STS304 측면

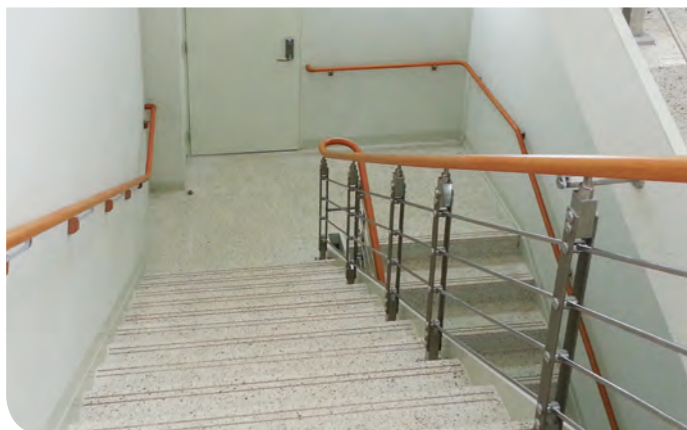

**Tempered Glass infill type Baluster**  
유리형 난간지주

**The best choice for degree of building's completion**

- 900/1200/1500mm high Baluster. (Standard size)
- Applied with Tempered glass. (8mm, 10mm, 12mm)

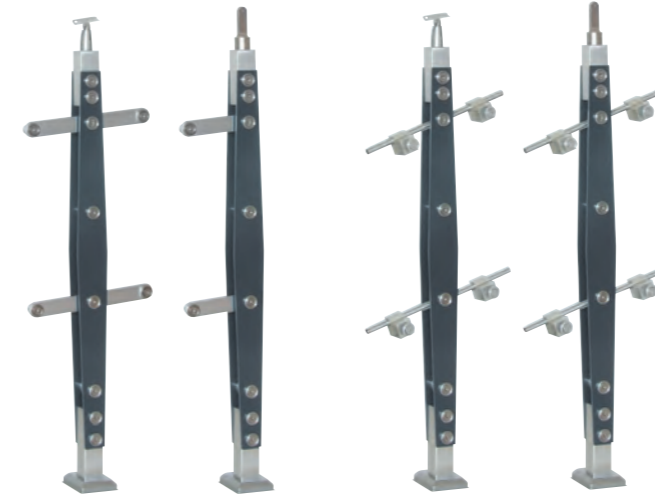

PS-G Type  
평철 + 분체도장 측면

PS-G2 Type  
평철 + 분체도장 측면

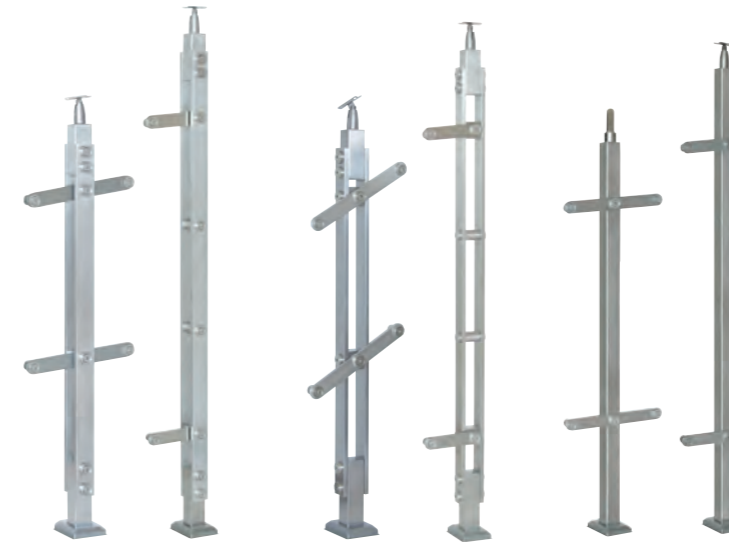

SU-G Type  
STS304 측면

SU-GX Type  
STS304 측면

SP-G Type  
STS304 사각파이프

**Custom Order Made Banister**  
난간지주 주문제작

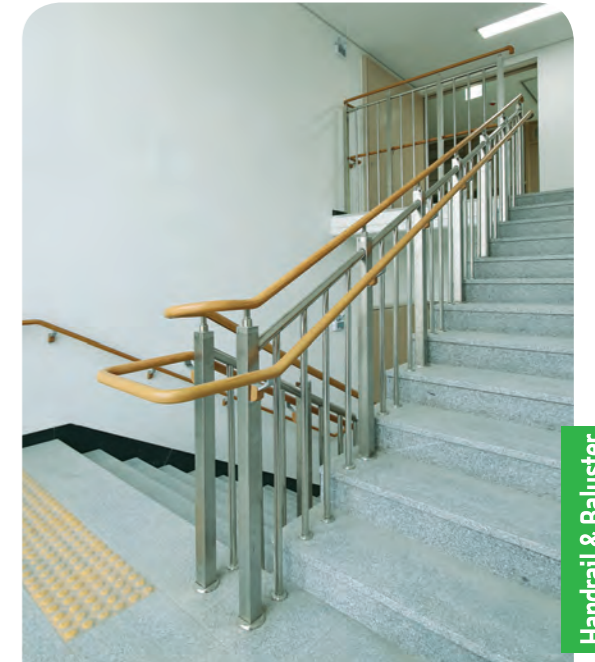

**NEW**

**Clear View Glass Railing**  
클리어뷰 유리난간

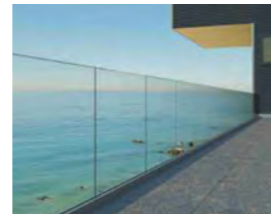

**CODEVAL**  
ALUMINIUM

깨끗한 시야 확보가 가능한 안전한 유리난간

- 세로바 형태의 지주가 없어 시야를 가리지 않는 뷰 확보
- 하부 하드웨어와 강화접합유리로 기존 금속난간 이상의 안전성 확보
- 유럽 기준 유리난간인증 통과 (CTE 수평하중 정적시험 완료)
- 스페인 발렌시아 공장 직수입

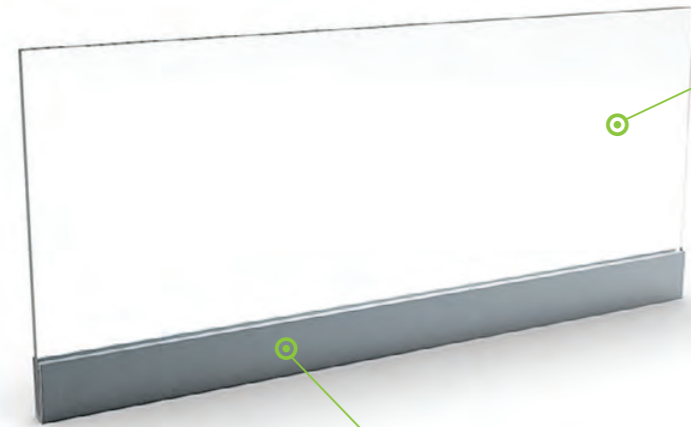

접합강화유리

하부하드웨어



**CODEVAL**  
ALUMINIUM

**NEW**

**Clear View Glass Railing**  
클리어뷰 유리난간

기본/매립 설치용 하드웨어

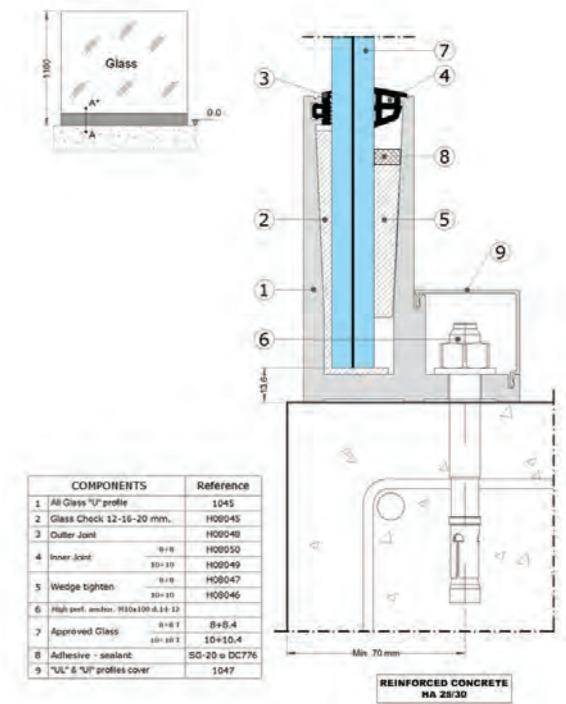
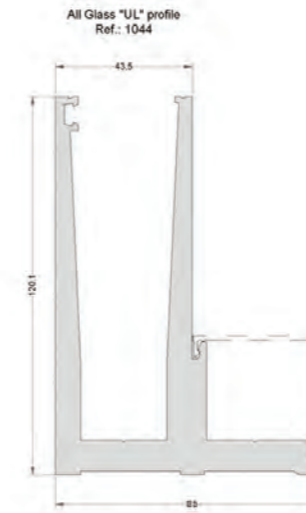

Handrail & Baluster System



측면 설치용 하드웨어

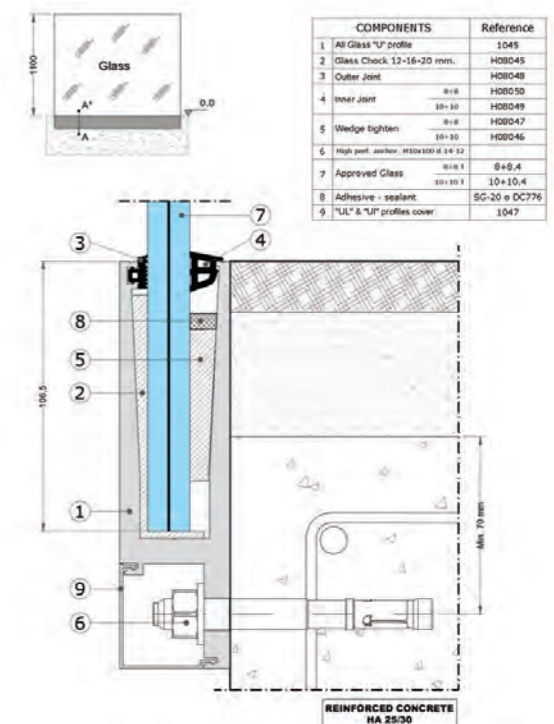



**Deluxe Grab-bar**  
디럭스 안전손잡이

Available CuS-Rail



- \* 유니버설디자인 인증획득 (인증번호: KUD-2022P004)
- \* 디럭스 안전손잡이는 TÜV SÜD 하중시험인증 제품입니다.
- \* HAEMA Deluxe grab bar passed the load test conducted by TÜV SÜD.

**HAEMA Soft-feel surface Deluxe Grab bar**

- Hand grip part 33.4mm in diameter
- 4mm thick soft synthetic resin cover
- 1.5mm thick stainless steel pipe core
- 3mm thick stainless steel bracket pad
- Custom length available

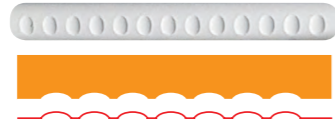

**Dimple pattern**  
\* 전 제품 옵션 적용가능  
\* Available to apply for all range of Grab bar.

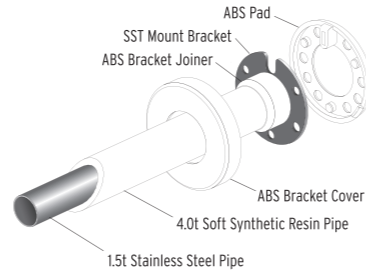

**다양한 사이즈 및 디자인의 주문생산 고려사항**

- 장애인화장실의 경우 법정규격을 준수하여 설치해야 합니다.
- 〈 L형 안전손잡이: 900 X 600mm, 접이식 안전손잡이: 700mm 내외 〉
- 디럭스 안전손잡이를 BF인증 적용현장에 설치시 최우수 배점이 적용됩니다.
- BF인증 현장의 세면대에는 접이식 안전손잡이를 좌우에 설치하여야 합니다.
- 소량의 비규격 사이즈도 주문생산 가능합니다.

**Check-up point for Order made products**

- Must be installed in accord with the standards and regulations for Handicapped restroom.
- Provide warm and soft touch with Synthetic resin finish.
- Lower the danger of electric shock accident by metal concealing structure.

**"I" Grab bar / 기본형 안전손잡이**



GB1030~1100  
L:300~1000mm



GB1101~1140  
L:1010~1400mm (T연결부 사용)



GB1~  
Custom length (T연결부 사용)

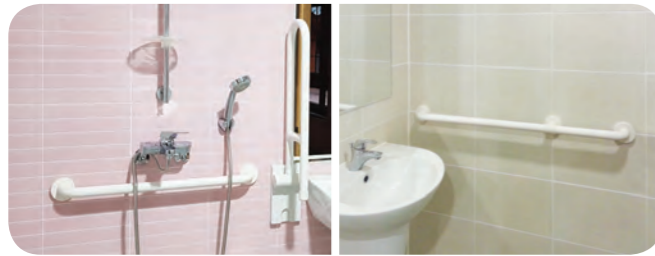

**"L" Grab bar / L형 안전손잡이**



GB26040R  
600×400mm

GB29060R  
900×600mm

GB26040L  
GB29060L



**Deluxe Grab-bar**  
디럭스 안전손잡이

Available CuS-Rail



- \* 제품 주문시 기본타입 스크루와 피셔 또는 힐티 앵커를 제공합니다.
- \* Provided FISHER or HILTI plastic anchors and screws.

**NEW**

**"P" Lift-up Grab bar with Leg / P형 접이식 안전손잡이**

GB570P  
L:700mm

GB560P  
L:600mm

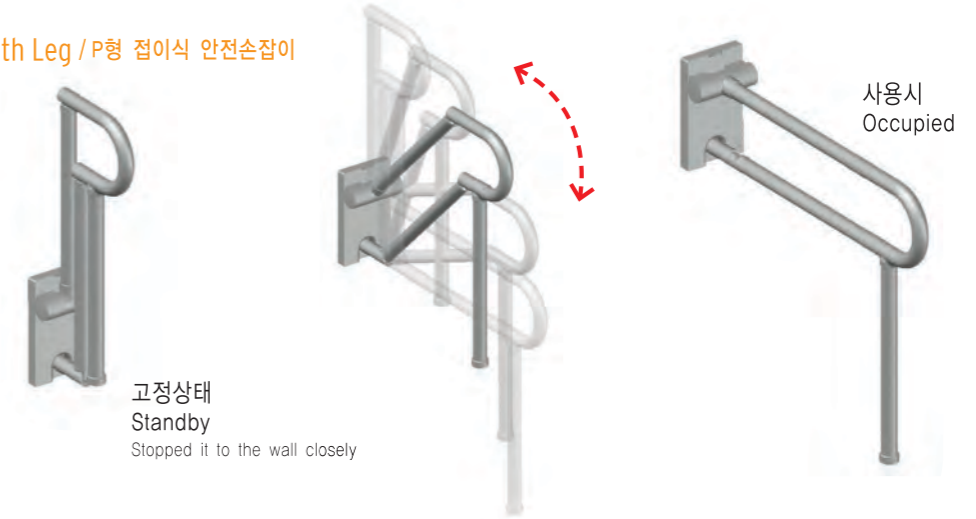

**고정상태 Standby**  
Stopped it to the wall closely

**사용시 Occupied**

**Lift-up Grab bar (Standard) / 기본형 접이식 안전손잡이**

**사용시 Occupied**



GB570SU  
L:700mm

GB550SU  
L:500mm

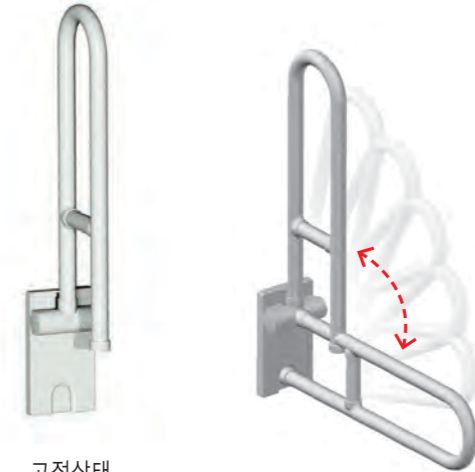

**고정상태 Standby**  
Stopped it to the wall closely

**딴플적용가능(Dimple Pattern)**



- \* Easy lift-up & safe safe drop-down by specifically designed device.
- \* 특별히 고안된 장치를 내장하여 노약자도 가볍게 들어올릴 수 있습니다.

※기본형 접이식 안전손잡이의 제작가능 최소길이는 450mm 입니다.



**Backrest / 등받이**



GB930T  
300×225mm



GB930L  
300×200mm



**Deluxe Grab-bar**  
디럭스 안전손잡이

Available CuS-Rail 

Urinal Grab bar / 소변기용 안전손잡이

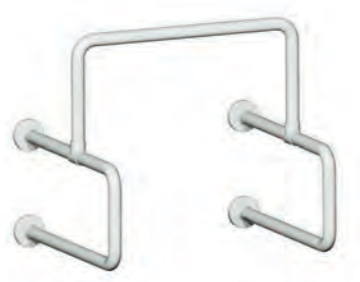

GB6550  
550x600mm



Wash Basin Grab bar / 세면대용 안전손잡이



GB7550C  
Custom size



"U" Grab bar / U형 안전손잡이



GB560FL  
L:600mm

GB560FR



"D" Grab bar / D형 안전손잡이



GB415D  
L:150mm

GB460D  
L:600mm

Washstand Grab bar / 세면대 상판용 안전손잡이



GB7150  
Custom size



**Deluxe Grab-bar**  
디럭스 안전손잡이

Available CuS-Rail 

"W" Grab bar / W형 안전손잡이



GB360  
H:570mm

GB390  
H:870mm



Angle Adjustable Mirror / 각도조절 거울

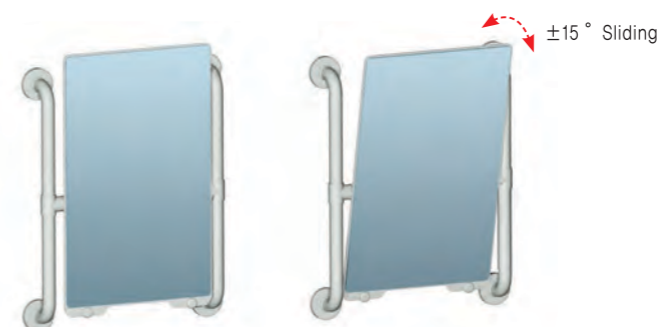

GB4065  
400x650mm(Mirror size)

- Operate about 15-degree by manual sliding
- W400 x H650mm, 5mm thick plat mirror
- W410 x H680mm, 2.3mm thick Steel base panel



Lift-up Shower seat / 접이식 샤워시트

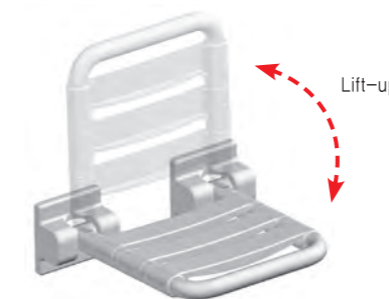

GB84040M  
420x390mm (seat)  
512x135mm (wall)

135-degree Grab bar / 135° 형 안전손잡이

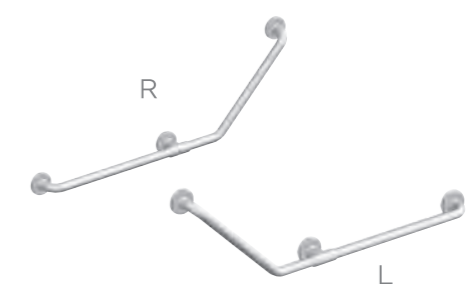

GB34070R/L  
400x700mm

Baby Care System  
영유아 보호용품

Diaper Changing Station  
기저귀 교환대



HBS-810 가로형  
820(W) x 550(H) x 145(D) Close  
820(W) x 130(H) x 550(D) Open



- 사용시 편의를 고려한 상단 약세서리 선반 & 가방걸이
- 유선형 디자인으로 청소 및 관리가 용이
- 아기의 안전을 위한 38mm 안전벨트를 적용
- 영유아의 추락을 방지하는 사방 막힘구조
- 무독성 소재 사용

- Streamlined Design for easy maintenance
- Child restraint system by 38mm seat belt
- Fall prevention design by close structure
- Non-toxic PE material
- ABS accessory  
End cap, Belt buckle



HBS-820 세로형  
550(W) x 860(H) x 145(D) Close  
550(W) x 130(H) x 860(D) Open

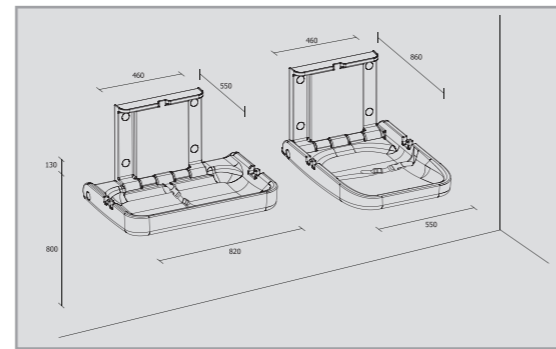

HBS-810/820

Infant Protection Seat  
영유아 보호의자



HBS-890  
320(W) x 500(H) x 140~320(D)



- 영유아 머리를 보호하는 디자인
- 아기의 안전을 위한 38mm 안전벨트를 적용
- 영유아의 추락을 방지하는 좌우 막힘구조
- 무독성 소재 사용

- Design for Baby's head safety
- Child restraint system by 38mm seat belt
- Fall prevention design by close structure
- Non-toxic PE material
- ABS accessory  
End cap, Seat top cap, Belt buckle

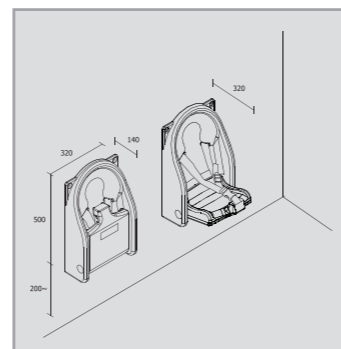

HBS-890



Curtain Track System  
커튼 트랙

NEW

Anti Droplet Urethane Curtain  
비말차단 우레탄 커튼



Cubicle Track System  
큐비클 커튼트랙



- 환자의 프라이버시를 고려한 자유로운 동선설계
- 천정높이에 따른 맞춤형 커튼길이 제작
- 무재봉선 광폭 원단(폭 70인치)
- 망사길이: 최대 40cm
- 모든 원단 방염처리

- Personal space effect in a Multiple patients room
- Custom-made available
- Wide Seamless fabric (W : 70inch)
- Mesh length : Max. 40cm
- Excellent performance in the flame retardant test

I.V Track System  
수액걸이 시스템



I.V Hook

Hanging 2 Points with Wall Mounted

- 화장실, 휴게실, 복도 등에 설치
- 접이식



I.V Tree & Locking Trolley

Hanging 5 Points with I.V Track Mounted

- 응급실, 중환자실, 수술실 등에 설치
- 높낮이 조절 가능 (65~110cm)
- 접이식

STANDARD FABRICS

※The color of the real product may be differently seen depending on the type of light, an intensity of illumination. (실제제품의 색상은 조명의 종류, 조도 등에 따라서 다르게 보일 수 있습니다.)

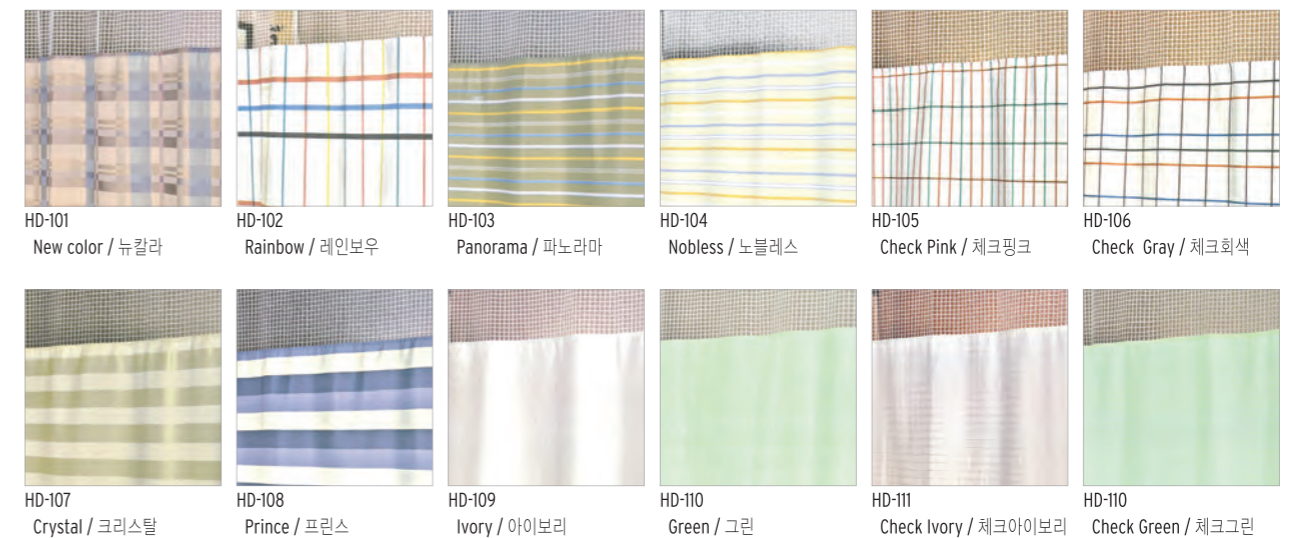

HD-101 New color / 뉴칼라	HD-102 Rainbow / 레인보우	HD-103 Panorama / 파노라마	HD-104 Nobless / 노블레스	HD-105 Check Pink / 체크핑크	HD-106 Check Gray / 체크회색
HD-107 Crystal / 크리스탈	HD-108 Prince / 프린스	HD-109 Ivory / 아이보리	HD-110 Green / 그린	HD-111 Check Ivory / 체크아이보리	HD-110 Check Green / 체크그린